

8 7 6 5 4 3 2 1

H
G
F
E
D
C
B
A

H
G
F
E
D
C
B
A

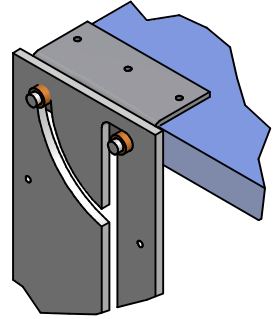
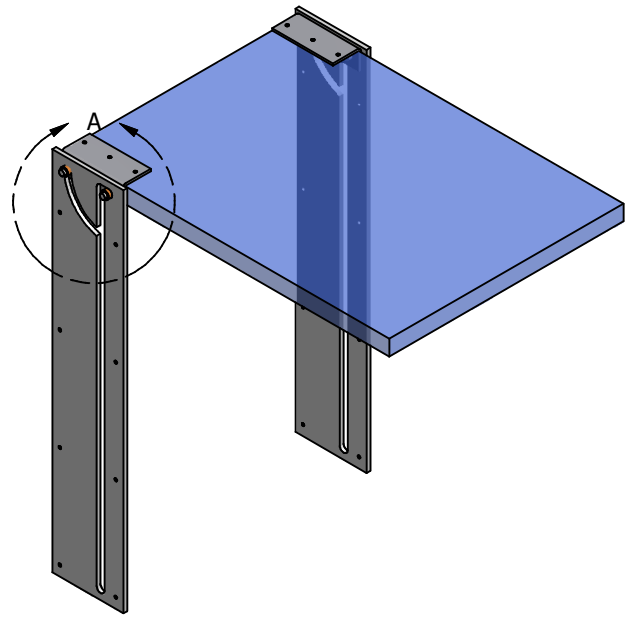
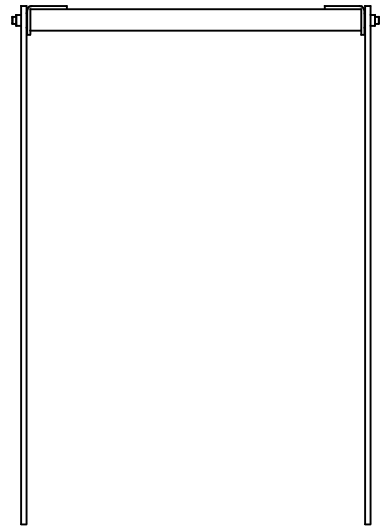
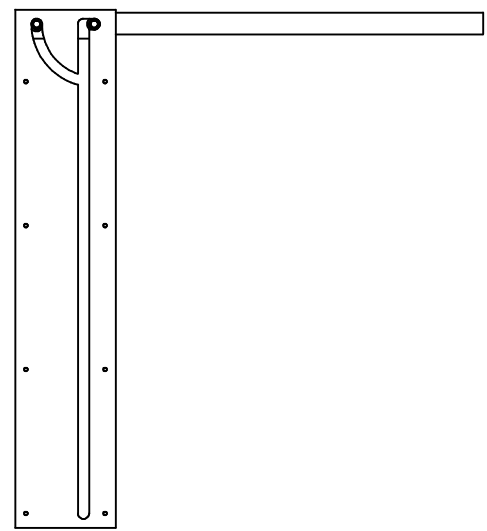
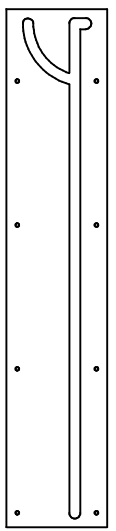
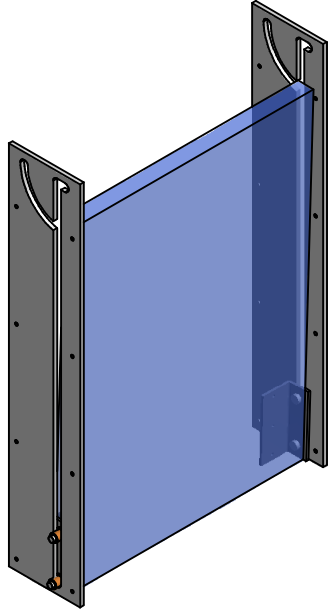

DETAIL A
SCALE 0.60 : 1

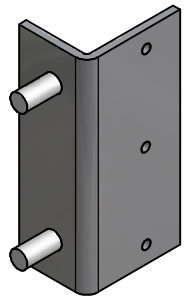

Tolerance	Bends: +/- 1/16"	DESCRIPTION Drop Table Bracket
Part #	tba	
Author	mike	FLEMING SALES
Date	8/4/06	
Material Gage	varies	
Material Type	varies	
Finish	raw	
Title Version	0.3 1-16-06	

8 7 6 5 4 3 2 1